

# ◆ 絶縁サポート (丸型) ◆

## ■ TSP15

φ8支柱、M3

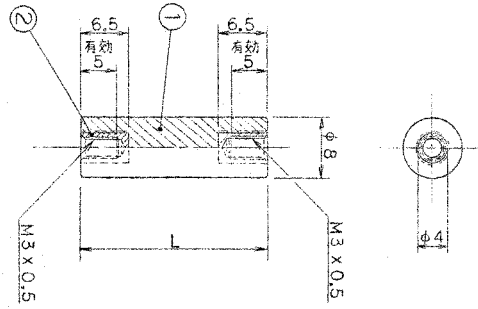

### ● L寸法表

TSP15-10	※
15	
20	
25	
30	
35	
40	

型名指定方法  
TSP15-□-CF

↳ Cd75ppm未満 (RoHS)

材質：PBT (黒色)、黄銅、洗処理

※ TSP15-10はインサートなし

## ■ TSI5

φ5支柱、M2.6

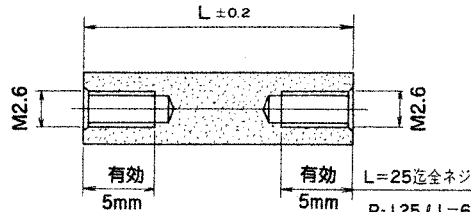
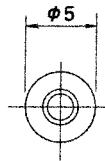
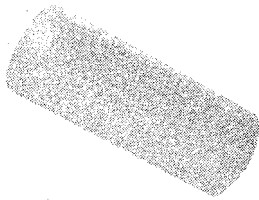

### ● L寸法表

TSI5-5	TSI5-14
6	15
7	16
8	17
9	18
10	19
11	20
12	25
13	30

右記寸法以外は、500本以上で製作可

材質：ポリアセタール (POM)、乳白色、UL94-HB

## ■ TSI6

φ6支柱、M3

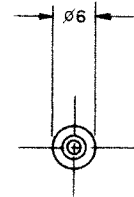
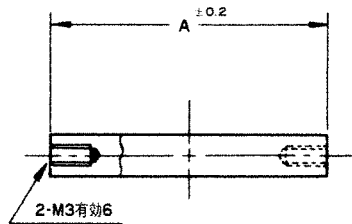
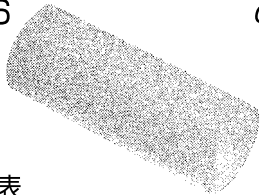

### ● L寸法表

TSI6-5	TSI6-10	TSI6-15	TSI6-20	TSI6-25	TSI6-30	TSI6-35	TSI6-40
6	11	16	21	26	31	36	45
7	12	17	22	27	32	37	50
8	13	18	23	28	33	38	55
9	14	19	24	29	34	39	60

上記寸法以外は、500本以上で製作可

材質：ポリアセタール (POM)、乳白色、UL94-HB

## ■ TSI8

φ8支柱、M4

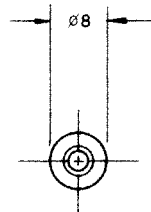
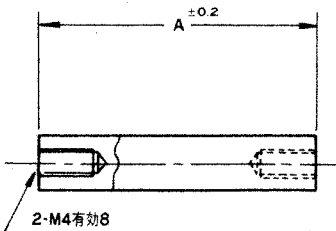
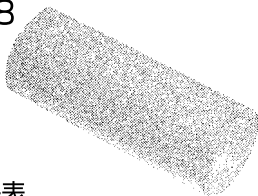

### ● L寸法表

TSI8-5	TSI8-10	TSI8-15	TSI8-20	TSI8-25	TSI8-30	TSI8-55	TSI8-100
6	11	16	21	26	35	60	
7	12	17	22	27	40	70	
8	13	18	23	28	45	80	
9	14	19	24	29	50	90	

上記寸法以外は、500本以上で製作可

材質：ポリアセタール (POM)、乳白色、UL94-HB